

ULTRA

ULTRA EFFICIENT SHOWER TRAYS

DIMENSIONS ULTRA SHOWER TRAYS.

20mm Centre Drain

20 x 800 x 1200mm

20 x 900 x 1200mm

20 x 1200 x 1200mm

20 x 1500 x 1500mm

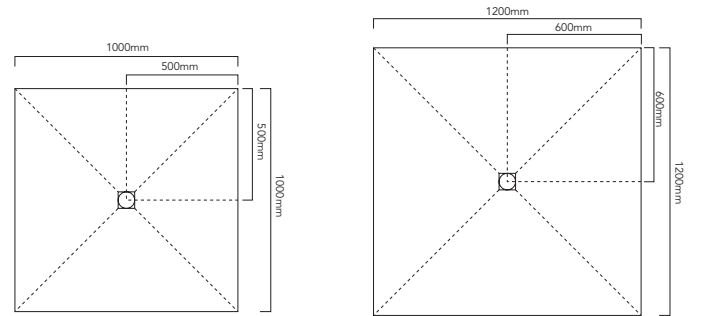
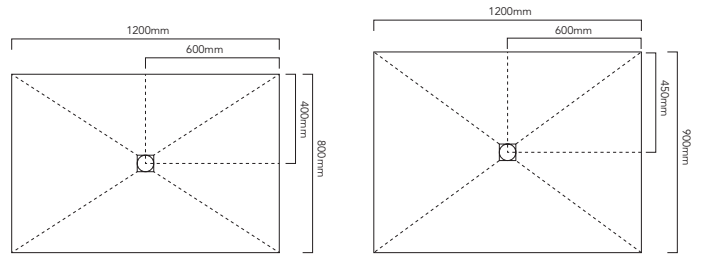

20mm Corner Drain

20 x 1000 x 1000mm

20 x 900 x 1200mm

20 x 1200 x 1200mm

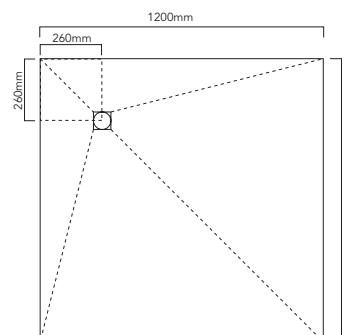
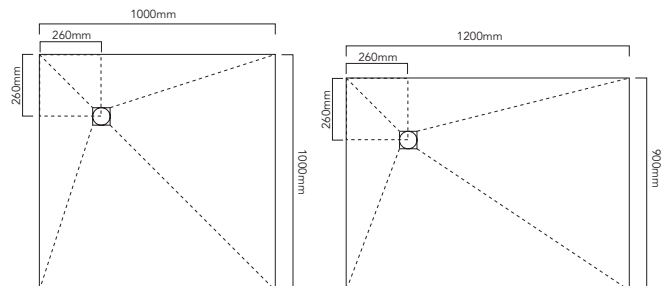
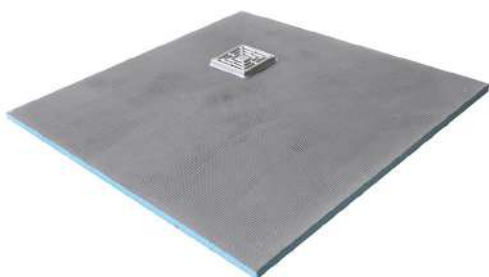

20mm & 25mm Offset Drain

20 x 800 x 1200mm

20 x 900 x 1200mm

25 x 800 x 1500mm

25 x 900 x 1500mm

25 x 900 x 1800mm

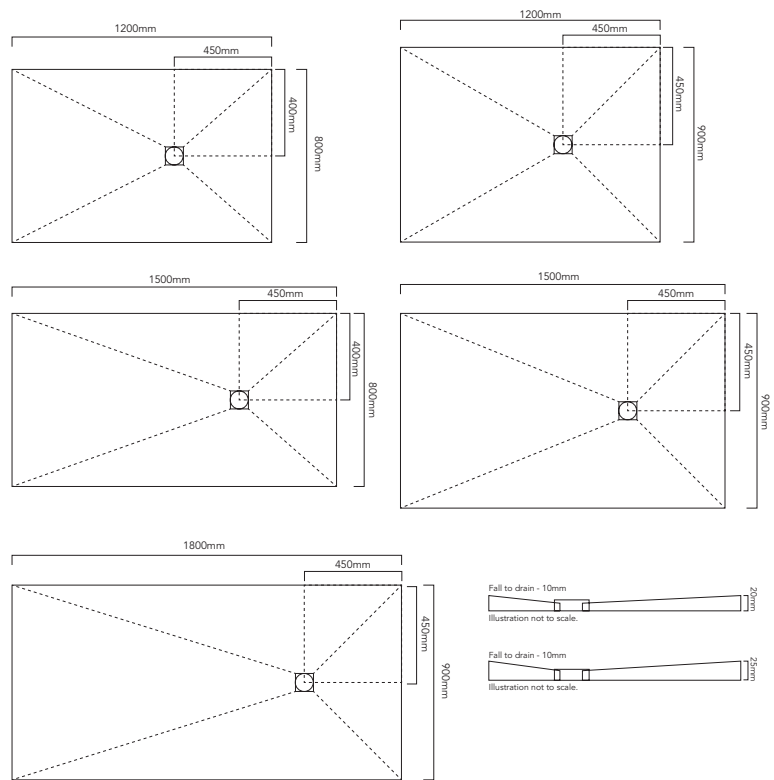

Linear Drain

30 x 900 x 900mm

30 x 900 x 1200mm

30 x 900 x 1500mm

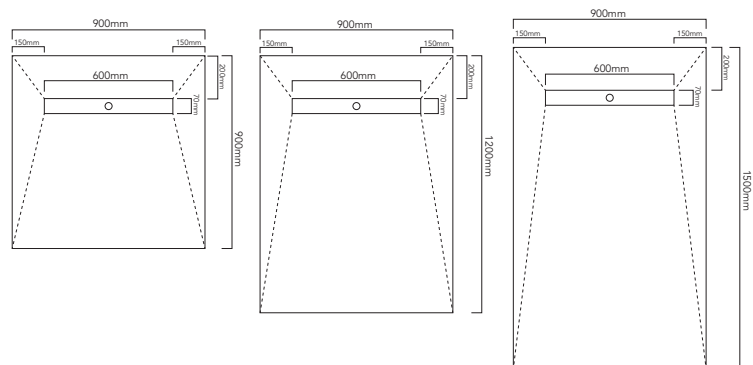

Ultra Shower Drain's are designed for use with Ultra Shower Tray's. Key features and benefits of the drains are as follows:

- 80mm maximum depth below the shower tray
- 40mm diameter connection to the mains, 50mm connection to the elbow
- Comes with extension frames for thicker tiles
- Stainless steel drain grille (115mm)
- 54 litres per minute flow rate

Contact Us

Tyne Insulation Supplies Ltd
Orion Way
Orion Business Park
North Shields
Tyne & Wear, NE29 7SN

Tel: 0191 257 8640
Fax: 0191 257 8413

www.tyneinsulation.co.uk

ULTRA

**TYNE
INSULATION
SUPPLIES LIMITED**